

DESCRIZIONE - DESCRIPTION

Art. **061**: Kit copritubo tondo 2 pezzi
Round pipe cover set 2 pcs

Art. **062**: Kit copritubo int. 50 mm.
Pipe cover set with 50 mm center distance.



TA

BB - RAL 9016

NN - RAL 9004



TA

BB - RAL 9016

NN - RAL 9004

CARATTERISTICHE - FEATURES

- Rosone in ottone CW614N
- Tubo in ottone CW508L
- O-rings in gomma EPDM
- Brass CW614N wall plate
- Brass CW508L tube
- EPDM rubber O-rings

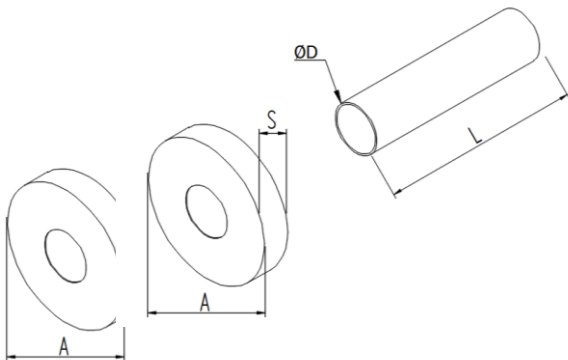
DIMENSIONI PRINCIPALI - LEADING DIMENSIONS

061

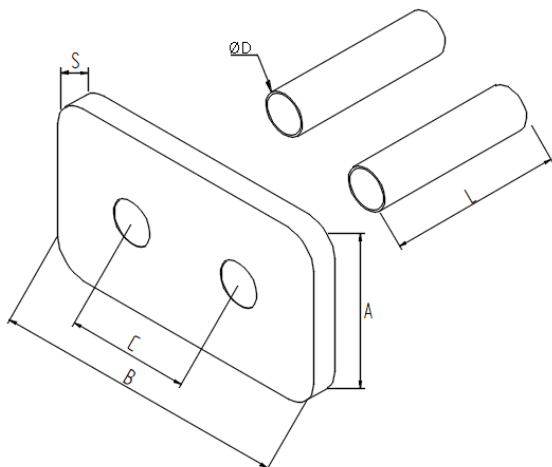
D	A	S	L	Tube-Pipe Ø
18	50	12.5	70-160	12-14-15-16

062

D	A	S	B	C	L	Tube-Pipe Ø
18	35	12.5	120	50	70-160	12-14-15-16